



Akshar[®]

INDUSTRIES



We manufacture
Power Tools, Armatures, Field Coils, and
Spare Parts, and deal with them.



www.aksharindustry.in

About Us

Incepted in the year 2009, at Ahmadabad [Gujarat, India], we are leading Manufacturer and Supplier of a commendable array of Power Tools[Hand Tools], Armature, Field Coils & Spare Parts. We are a Partnership firm serving our customers with dedication. Our offered products are manufactured with precision using good grade raw material and ultramodern technology in complete compliance with the industry laid standards of quality. The offered products are examined by our skilled quality controllers to ensure its flawlessness and performance efficiency. The offered products are made available for our valued clients at reasonable rates.



Visit Us

www.aksharindustry.in



Our Mission

To consolidate and expand our leadership and presence in the international market with strong efforts being addressed to insufficiently protected markets. Along with an upgraded infrastructure; we also possess a team of highly qualified and experienced professionals.

Why Choose Us!



Trust

We build trust with the client



Innovation

We believe in innovation



Expert Engineers

If you're going to be stupid, you have to be tough!



Projects Support

Make your plant the best, safer than all the rest



Experience

15+ years of experience



Excellence In Quality

Never compromise on quality



Industrial Ideas

Ignoring a warning can cause much mourning



Modern Equipment

Life did not begin by accident. don't end it as one





Installed Capacity

Good Quality Expertise



Power Tools

Production capacity: 50000 machines per month, 80 feet belt conveyer system with testing facilities.

Total staff for assembly: 80

Product range:

- Marble Cutters (4",5",7")
- Wood Cutters (4",5",7")
- Angle Grinder (4",5",7")
- Hand Drills(R/F) (10",13",20")
- Air Blowers



Armature

Production capacity: 2 Lac pcs per month, 4 fully automatic production line

Total staff: 55

Product Range:

A/C Armature For

- Marble Cutters
- Hand Drills
- Angle Grinder
- Air Blowers
- Demolition Hammer
- Cut of Machine

D/C Armature For

- 12v-Agriculture Pump
- 24v-Bustoor Pump



Installed Capacity

Good Quality Expertise

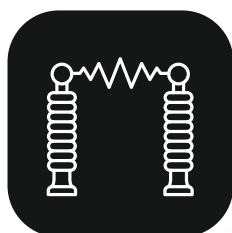

Field Coils

Production capacity: 50000 pcs per month

Total staff: 40

Product range:

- Marble Cutters
- Hand Drills
- Angle Grinder
- Air Blowers
- Demolition Hammer
- Cut of Machine



Spare Parts

Production capacity for plastic spare: for 50000 pcs machines with in-house molding machine and all related tooling,

Machine accessories: spanners, plates, cables, fan, star, Gear Set, Gear Box, Carbon Brushes, Switches, Spindles.

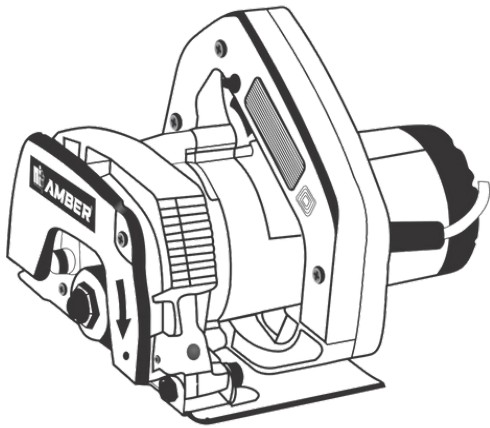
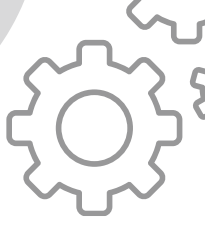

Amber ACM-04

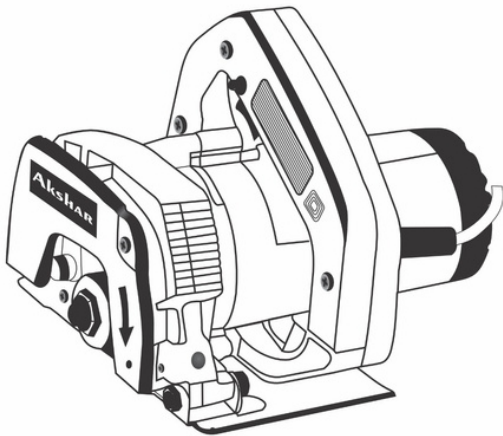

MARBLE CUTTER

MATERIAL TYPE	: PA6GF30%
CAPACITY	: 110 mm
POWER INPUT	: 1050 W
AMP	: 1.8 Amp [No Load]
RPM	: 12000 [No Load]
WEIGHT	: 3.400 KG
DURABILITY	: 3 Years
WARRANTY	: 6 Month
CODE WIRE	: 0.5 Sq./mm [ISI] Copper
BEARING	: 2RS V2



Akshar AI CM-04

MARBLE CUTTER

MATERIAL TYPE	: PA6GF30%
CAPACITY	: 100-125 mm
POWER INPUT	: 1250 W
AMP	: 1.8 Amp [No Load]
RPM	: 12000 [No Load]
WEIGHT	: 4.00 KG
DURABILITY	: 3 Years
WARRANTY	: 6 Month
CODE WIRE	: 0.5 Sq/mm [ISI] Copper
COLOR OPTION	:  
BEARING	: 2RS V3





AIR BLOWER

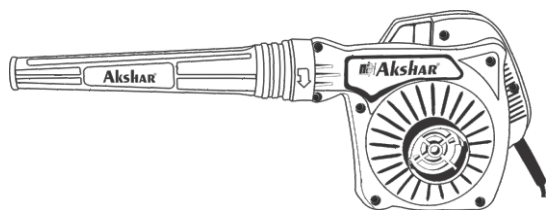

Akshar AI-0040

MATERIAL TYPE	: PP GF30%
CAPACITY	: 850 W
AMP	: 3.3 Amp [No Load]
RPM	: 13000 [No Load]
AIR FLOW	: 4.0 [MTR] ³
WEIGHT	: 2.500 KG
DURABILITY	: 3 Years
WARRANTY	: 1 Years
CORD WIRE	: 0.5 Sq/mm [ISI] Copper
BEARING	: 2RS V3



AIR BLOWER

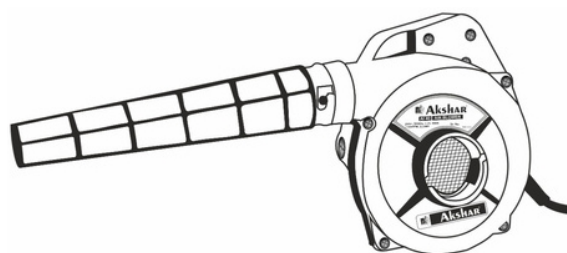

Akshar HNL AI-40

MATERIAL TYPE	: PA6GF30%
CAPACITY	: 650 W
AMP	: 2.2 Amp [No Load]
RPM	: 11000 [No Load]
AIR FLOW	: 3.2 [MTR] ³
WEIGHT	: 2.00 KG
DURABILITY	: 5 Years
WARRANTY	: 1 Year
CORD WIRE	: 0.5 Sq/mm [ISI] Copper
COLOR OPTION	: 
BEARING	: 2RS V3/V2





AIR BLOWER

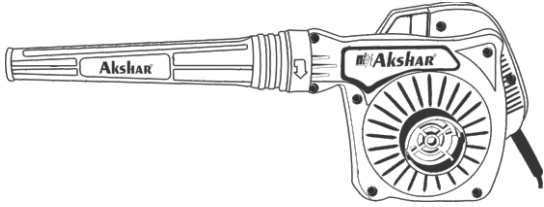

Akshar AI 007

MATERIAL TYPE	: PP
CAPACITY	: 650 W
AMP	: 2.2 Amp [No Load]
RPM	: 11000 [No Load]
AIR FLOW	: 3.2 [MTR] ³
WEIGHT	: 1.800 KG
DURABILITY	: 3 Years
WARRANTY	: 6 Month
CORD WIRE	: 0.5 Sq/mm [ISI] Copper
BEARING	: 2RS V3



AIR BLOWER

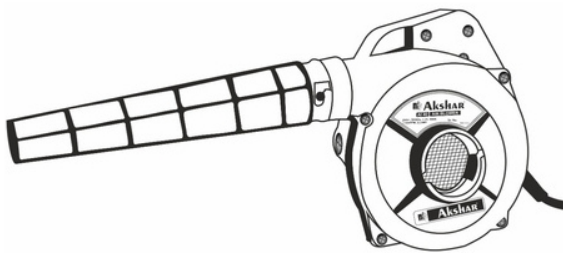

Akshar HGV AI-40

MATERIAL TYPE	: PPGF30%
CAPACITY	: 650 W
AMP	: 2.2 Amp [No Load]
RPM	: 11000 [No Load]
AIR FLOW	: 3.2 [MTR] ³
WEIGHT	: 1.800 KG
DURABILITY	: 3 Years
WARRANTY	: 6 Months
CORD WIRE	: 0.5 Sq/mm [ISI] Copper
BEARING	: 2RS V3





AIR BLOWER

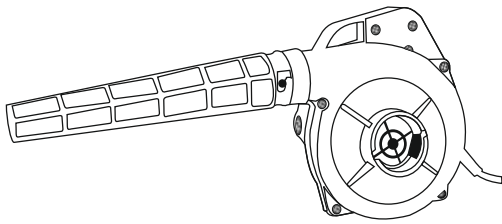

Eagle EG-40

MATERIAL TYPE	: PP
CAPACITY	: 500 W
AMP	: 2.2 Amp [No Load]
RPM	: 11000 [No Load]
AIR FLOW	: 3.2 [MTR] ³
WEIGHT	: 1.4 KG
DURABILITY	: 3 Years
CORD WIRE	: 0.5 Sq/mm [ISI] Copper
BEARING	: 2RS V2



AIR BLOWER

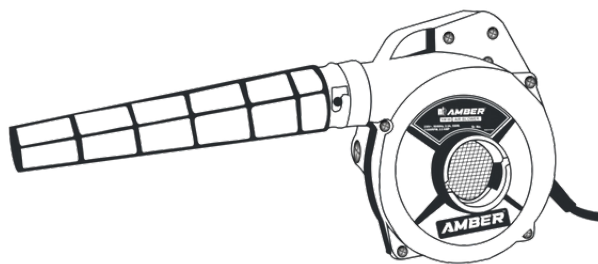

Amber UNB-88

MATERIAL TYPE	: PP
CAPACITY	: 550 W
AMP	: 2.2 Amp [No Load]
RPM	: 11000 [No Load]
AIR FLOW	: 3.2 [MTR] ³
WEIGHT	: 1.8 KG
DURABILITY	: 3 Years
WARRANTY	: 6 Month
CORD WIRE	: 0.5 Sq/mm [ISI] Copper
COLOR OPTION	: 
BEARING	: 2RS V2

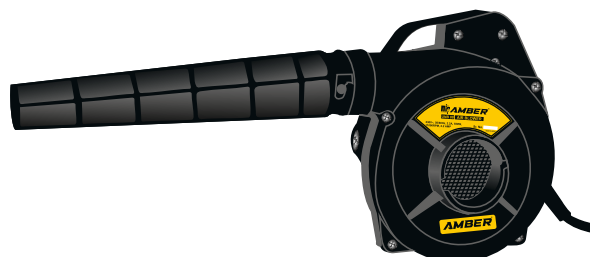





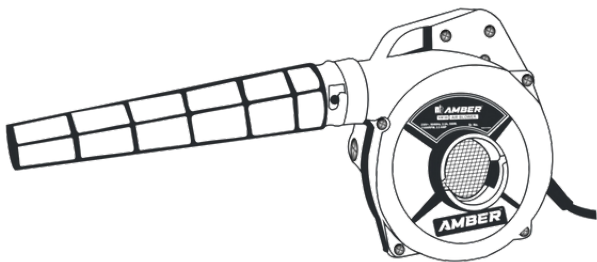

AIR BLOWER



Amber AM-88





MATERIAL TYPE	: PP
CAPACITY	: 550 W
AMP	: 2.2 Amp [No Load]
RPM	: 11000 [No Load]
AIR FLOW	: 3.2 [MTR] ³
WEIGHT	: 1.6 KG
DURABILITY	: 3 Years
WARRANTY	: 6 Month
CORD WIRE	: 0.5 Sq/mm [ISI] Copper
COLOR OPTION	:    
BEARING	: 2RS V2

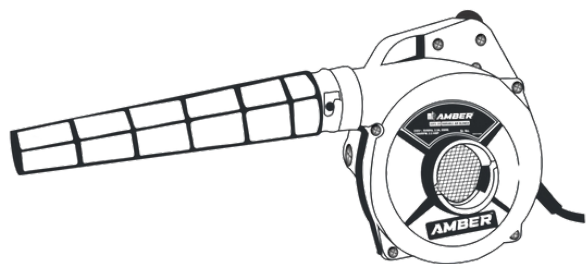

AIR BLOWER



Amber variable
Speed AMV-88

MATERIAL TYPE	: PP
CAPACITY	: 550 W
AMP	: 2.2 Amp [No Load]
RPM	: 11000 [No Load]
AIR FLOW	: 3.2 [MTR] ³
WEIGHT	: 1.6 KG
DURABILITY	: 3 Years
WARRANTY	: 6 Month
CORD WIRE	: 0.5 Sq/mm [ISI] Copper
COLOR OPTION	:    
BEARING	: 2RS V2





HAND DRILL

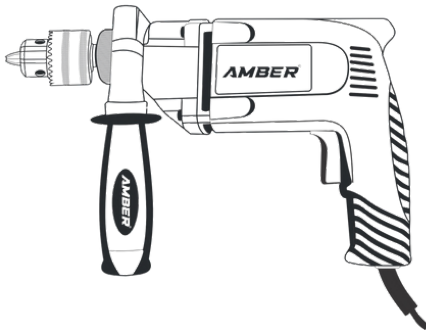

AMBER



MODEL NO. : AMDU 10, AM EID 13, AM POLISHER
 MATERIAL TYPE : PA6GF30%
 CAPACITY : 10 mm,13 mm
 POWER INPUT : 650 W
 AMP : 1 Amp [No Load]
 RPM : 1250/2250/2900 [No Load]
 WEIGHT : 2.500 KG
 DURABILITY : 3 Years
 WARRANTY : 6 Month
 CORD WIRE : 0.5 Sq/mm [ISI] Copper
 BEARING : 2RS V2



[AMEID 13,AMDU 10]



[AMPOLISHER]

HAND DRILL

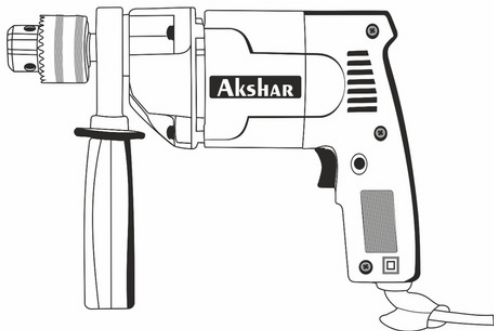

Akshar



MODEL NO. : AIDU 10, AIEID 13, AI POLISHER
 MATERIAL TYPE : PA6GF30%
 CAPACITY : 10 mm, 13 mm,
 POWER INPUT : 650 W
 AMP : 1 Amp [No Load]
 RPM : 1250/2250/2900 [No Load]
 WEIGHT : 2.600 KG
 DURABILITY : 3 Years
 WARRANTY : 6 Month
 CORD WIRE : 0.5 Sq/mm [ISI] Copper
 BEARING : 2RS V3



[AIEID 13,AIDU 10]



[AIPOLISHER]



ANGLE GRINDER

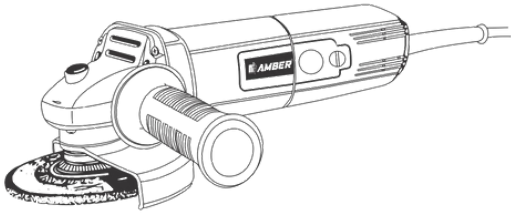

Amber AM-801

MATERIAL TYPE	: PA6GF30%
CAPACITY	: 100 mm
POWER INPUT	: 800 W
AMP	: 1.2 Amp [No Load]
RPM	: 12000 [No Load]
WEIGHT	: 2.00KG
DURABILITY	: 3 Years
WARRANTY	: 6 Month
CORD WIRE	: 0.5 Sq/mm [ISI] Copper
BEARING	: 2RS V2



ANGLE GRINDER

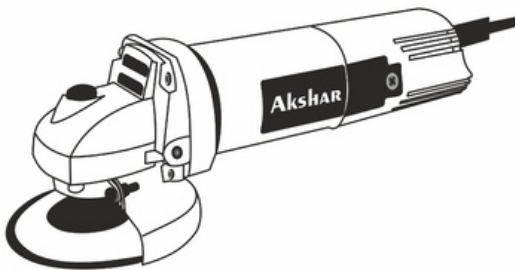

Akshar AI-801

MATERIAL TYPE	: PA6GF30%
CAPACITY	: 125 mm
POWER INPUT	: 980 W
AMP	: 1.2 Amp [No Load]
RPM	: 12000 [No Load]
WEIGHT	: 2.200 KG
DURABILITY	: 3 Years
WARRANTY	: 6 Month
CORD WIRE	: 0.5 Sq/mm [ISI] Copper
BEARING	: 2RS V3



ARMATURE SUITABLE FOR



ANGLE GRINDER ARMATURE



Armature-6-100



Armature-P-5502



Dewalt 801



G10SS Armature



G15SA2-5-Inch
Grinder



KPT-5791-Cobra



LG-PD-Armature



PD100-M-
Armature

MARBLE CUTTER MACHINE ARMATURE



Armature-CM4-
Plastic-Fan



Armature-CM4-SB



LG 355 Cut Off

HAMMER ARMATURE



Armature-2-20



HM0810-Armature-
Mini-Breaker



EBC-40Armature



FIELD COIL SUITABLE FOR



6-100 Field Coil



11-E Field Coil



20-180-Field Coil

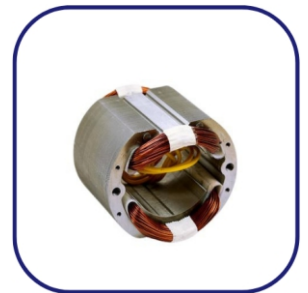

7614-NB-Field Coil



Blower-Field Coil
EBC-40



CC14SF-Field Coil

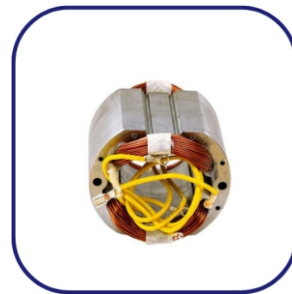

CC14STD Field Coils



CM4-Field Coil



COBRA-5791 Field
Coil

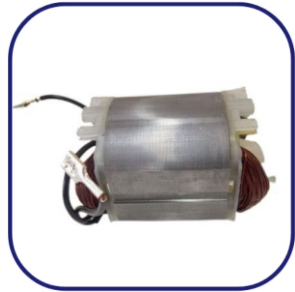

Field-Coil DW 801



Field Coil G15SA2



Field Coil G18SA2



Field Coil HM-810



GCO-2000
Field Coil

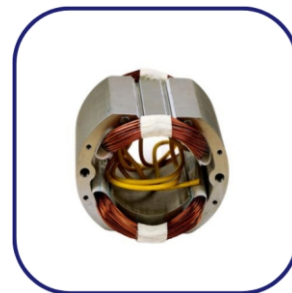

LG355 FIELD COIL

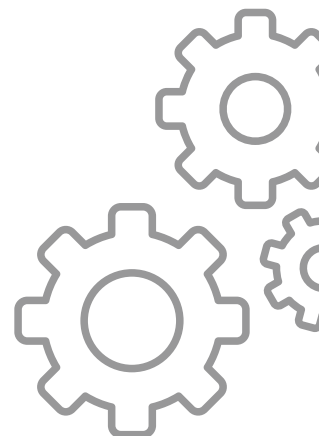

FIELD COILS - AMBER

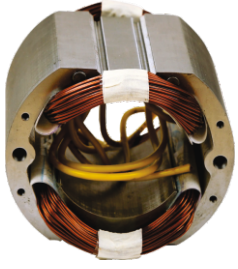

Amber LG 355

MODEL : LG355
Copper Wire : F Class
Copper Data : 19.5/85
Stamping : CRC-800
varnish Insulation : H Class (180°C)
Connection Wire : 1.0 sq/mm(ISI)
Total Weight : 1.800gm



Amber CM04

MODEL : CM04
Copper Wire : F Class
Copper Data : 23/105
Stamping : CRC-800
varnish Insulation : B Class (130°C)
Connection Wire : 0.5 sq/mm(ISI)
Total Weight : 685gm

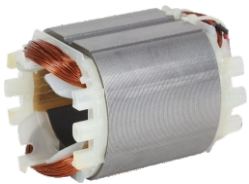

Amber D/W-801

MODEL : D/W-801
Copper Wire : F Class
Copper Data : 26/120
Stamping : CRC-800
varnish Insulation : B Class (130°C)
Connection Wire : 0.5 sq/mm(ISI)
Total Weight : 472gm



SPARE PARTS

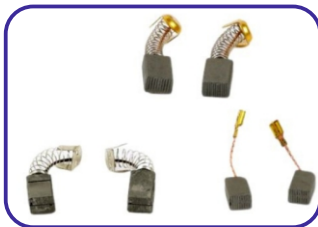

Carbon-Brush-Cm4



Dewalt-801-Gear-Pinion



Cm4-Gear-Box



Marble Cutter Cm4 Parts



Marble Cutter Cm4 Parts





Akshar[®]
INDUSTRIES

Thank You

We love hearing from you and supporting you.

Contact us and see how Akshar Industries can take your Requirement to the next level.

Visit Us

www.aksharindustry.in

9, Harekrishna Industrial Park,
Bakrol, Opp. Kanabha-Kujad,
Ahmedabad-382430

info@aksharindustry.in

sales@aksharindustry.in

Contact

Mr. Jayesh Kakadiya

 **+91 93762 76103**

Mr. Hemang Pansuriya

 **+91 9099 777 999**

Mr. Hitesh Kakadiya

 **+91 9081 818 222**



aksharindustries on WhatsApp.

WE **SUPPORT**

